

# LipuJet-S-OM Extension stage 2

## Product information for the product group

### ACO Product benefits

- Odour-free emptying, cleaning and filling
- Hydromechanical high-pressure cleaning – only a cold-water connection required
- Can be equipped with an disposal pump
- Minimises disposal and maintenance costs thanks to economic step increases in nominal size
- Small delivery dimensions
- Low weight

- Grease separator plant as per DIN EN 1825 and DIN 4040-100
- For indoors installation – frost free
- With integrated sludge trap
- Operating side: right/left
- Draining connection, fire hose quick coupling B 2½"
- Suction and emptying sump with drain plug socket 1"
- Inspection window with wiper
- Manual operation of the high pressure internal cleaning with pump
  - Nominal pressure: 175 bar
  - Capacity: 11,6 l/min
  - Chopping, mixing, rinsing in one process
- Odour-proof maintenance opening
  - Diameter: 300 mm for NS 1 – 4
  - Diameter: 500 mm for NS 5.5 – 10
- Filling device with ball valve (connection ¾") for manual refilling
- Electrical connector: 400 V/50 Hz/4,2 kW

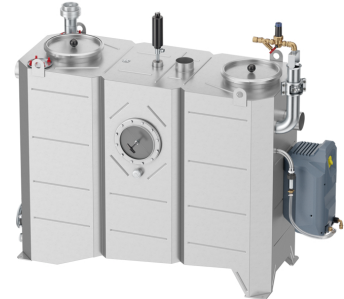

## Item Technical Data 7577.74.41

Nominal size	Nominal width	Contents			Weight		Operation side
		Sludge trap	Grease store	Overall	Empty	Full	
		[l]	[l]	[l]	[kg]	[kg]	
NS 7	DN 150	700	400	1600	290	1890	Right-hand

**Dimensions**

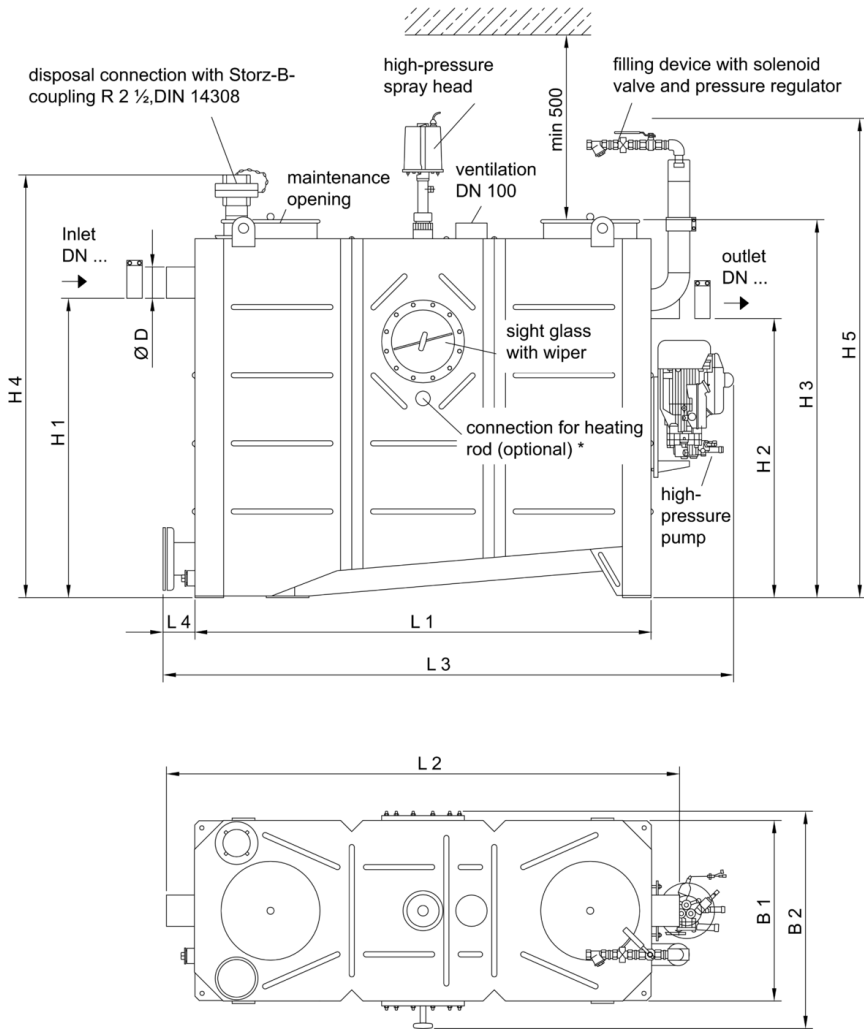





displayed:  
 NS4, operating side right  
 operating side left would show all component  
 (disposal connection, sight glass) positioned  
 mirror-inverted to axis.  
 \* not included in the scope of delivery

**Nominal size**

**Dimensions**

	L1	L2	L3	L4	H1	H2	H3	H4	H5	B1	B2	D
	[mm]	[mm]	[mm]	[mm]	[mm]	[mm]	[mm]	[mm]	[mm]	[mm]	[mm]	[mm]
NS 7	1855	2120	2270	115	1255	1185	1570	1750	1950	940	1010	160

## Accessories

	Description	Used with	Weight [kg]	Item number
	<b>Sampling pot DN 150</b> <ul style="list-style-type: none"> <li>■ Stainless steel, material grade 316</li> <li>■ Round shape</li> <li>■ Gradient drop: 70 mm</li> <li>■ For installation in DN 150 horizontal pipes coming from grease separator</li> <li>■ With EC connector and claw</li> <li>■ Connections tested to DIN EN 877</li> </ul>	<ul style="list-style-type: none"> <li>■ Grease separator LipuJet-S/Lipator-S                             <ul style="list-style-type: none"> <li>□ NS 5.5 – 10</li> </ul> </li> <li>■ Starch separator FapuJet-S                             <ul style="list-style-type: none"> <li>□ NS 2</li> </ul> </li> <li>■ Light oil separator Coalisator-R/-RD                             <ul style="list-style-type: none"> <li>□ NS 6 – 10</li> </ul> </li> </ul>	12.2	7300.09.20
	<b>Sampling pot DN 150</b> <ul style="list-style-type: none"> <li>■ Stainless steel, material grade 316</li> <li>■ Round shape</li> <li>■ For installation in DN 150 vertical pipes coming from grease separator</li> <li>■ With EC connector and claw</li> <li>■ Connections tested to DIN EN 877</li> </ul>	<ul style="list-style-type: none"> <li>■ Grease separator LipuJet-S/Lipator-S                             <ul style="list-style-type: none"> <li>□ NS 5.5 – 10</li> </ul> </li> <li>■ Starch separator FapuJet-S                             <ul style="list-style-type: none"> <li>□ NS 2</li> </ul> </li> <li>■ Light oil separator Coalisator-R/-RD                             <ul style="list-style-type: none"> <li>□ NS 6 – 10</li> </ul> </li> </ul>	11.3	7300.15.20
	<b>Viewing window</b> <ul style="list-style-type: none"> <li>■ Nominal width: DN 200</li> <li>■ With screen wiper</li> </ul>	<ul style="list-style-type: none"> <li>■ Grease separator LipuJet-S-OB/OD/RB/RD</li> </ul>	2.3	7602.00.26
	<b>Filling device</b> <ul style="list-style-type: none"> <li>■ Free outlet as per DIN 1988 Part 4</li> <li>■ For connection to drinking water supply</li> <li>■ With ball valve R 3/4"</li> </ul>	<ul style="list-style-type: none"> <li>■ Grease separator LipuJet-S-OB/OD/RB/RD</li> </ul>	2.3	7602.00.25
	<b>Grease layer thickness measuring device</b> <ul style="list-style-type: none"> <li>■ For electronic measurement of layer of grease</li> <li>■ Suitable for liquid and/or congealing grease</li> <li>■ Measuring device with plug and used connecting cable, length: 3 m</li> <li>■ With two voltage-free changeover contacts to display full warning (80%) and advance warning of fill level (50%)</li> <li>■ With visual display of fill level</li> <li>■ With heated probe rod to increase reliability of operation</li> <li>■ Operating voltage: 230VAC/5 VA</li> <li>■ Max consumption approx. 12W</li> </ul>	<ul style="list-style-type: none"> <li>■ LipuJet-P                             <ul style="list-style-type: none"> <li>□ Oval NS 1 – 10</li> <li>□ Round NS 2 – 22,5</li> </ul> </li> <li>■ LipuJet-S                             <ul style="list-style-type: none"> <li>□ Oval NS 1 – 10</li> <li>□ Round NS 2 – 20</li> </ul> </li> <li>■ LipuSmart-P                             <ul style="list-style-type: none"> <li>□ Oval NS 1 – 10</li> </ul> </li> </ul>	2.8	3300.11.50

You can find further accessories under → <https://www.buildingdrainage.aco/search/?q=7577.74.41>