

LipuJet-P-RA Extension stage 3

Product information for the product group

ACO Product benefits

- Easy to transport and assemble (incorporation in individual segments)
 - Optimum insertion dimension
 - Easier handling due to weight reduction
 - Rotatable inlet fitting and stretchable odor trap
 - Multifunctional container
 - Emptying, cleaning and filling without odor nuisance
 - Individually adjustable pre- and after-cleaning times
 - Hydromechanical high-pressure interior cleaning – cold water connection only necessary
- Grease separator according to EN 1825 - Nominal Sizes (5,5-22.5)
 - With integrated sludge trap
 - Container made of polyethylene, in segment construction
 - For indoor installation – frost-free
 - Fastening set for buoyancy-proof anchoring
 - Suction and drainage sump
 - Odour-tight maintenance opening (clear width Ø450 mm)
 - Odour-tight inspection opening through Inlet and outlet
 - Central connection for direct suction with fixed coupling and blind coupling
 - Inspection window with wiper
 - High-pressure internal cleaning:
 - Motor-driven high-pressure spray head (360° cleaning over two axles)
 - HP (high pressure) pump (nominal pressure 175 bar)
 - Filling unit (components with DVGW and KIWA approvals) for automatic refilling:
 - Free-flow valve
 - Pressure reducer with dirt trap
 - Solenoid valve
 - Odour trap
 - Level measurement via pneumatic pressure measurement including bubbler injection:
 - Pneumatic box with miniature compressor and pressure sensor
 - Pitot tube
- Control with connection cable 1.5 m
 - And CEE plug 16A including phase changer, protection class IP 54
 - Pipe connectors on the inlet and outlet with transition seal for pipe OD 210 mm
 - Execution right or left / following components are to be operated on the right or left to the central axis:
 - Inspection window
 - Direct suction
 - Filling unit
 - High pressure spray head
 - HP pump
 - Pneumatic box
 - Control
 - Declaration of Performance (DoP) No: BD-G1-1025
 - Connections:
 - Inlet and outlet DN200/OD200 mm
 - Vent DN100/OD110 mm
 - Direct suction with fixed coupling Storz-B/2½" and blind coupling
 - Water connection filling unit Rp¾"
 - Bottom outlet Rp1"
 - Electrical connection:
 - 400V/50Hz/16A/4.2 kW
 - Fusing: 3x16A (slow) or according to local conditions



Item Technical Data 3515.53.10

Nominal size	Nominal width	Contents			Weight		Operation side
		Sludge trap	Grease store	Overall	Empty	Full	
		[l]	[l]	[l]	[kg]	[kg]	
NS 15	DN 200	1550	600	3130	330	3460	left

Dimensions

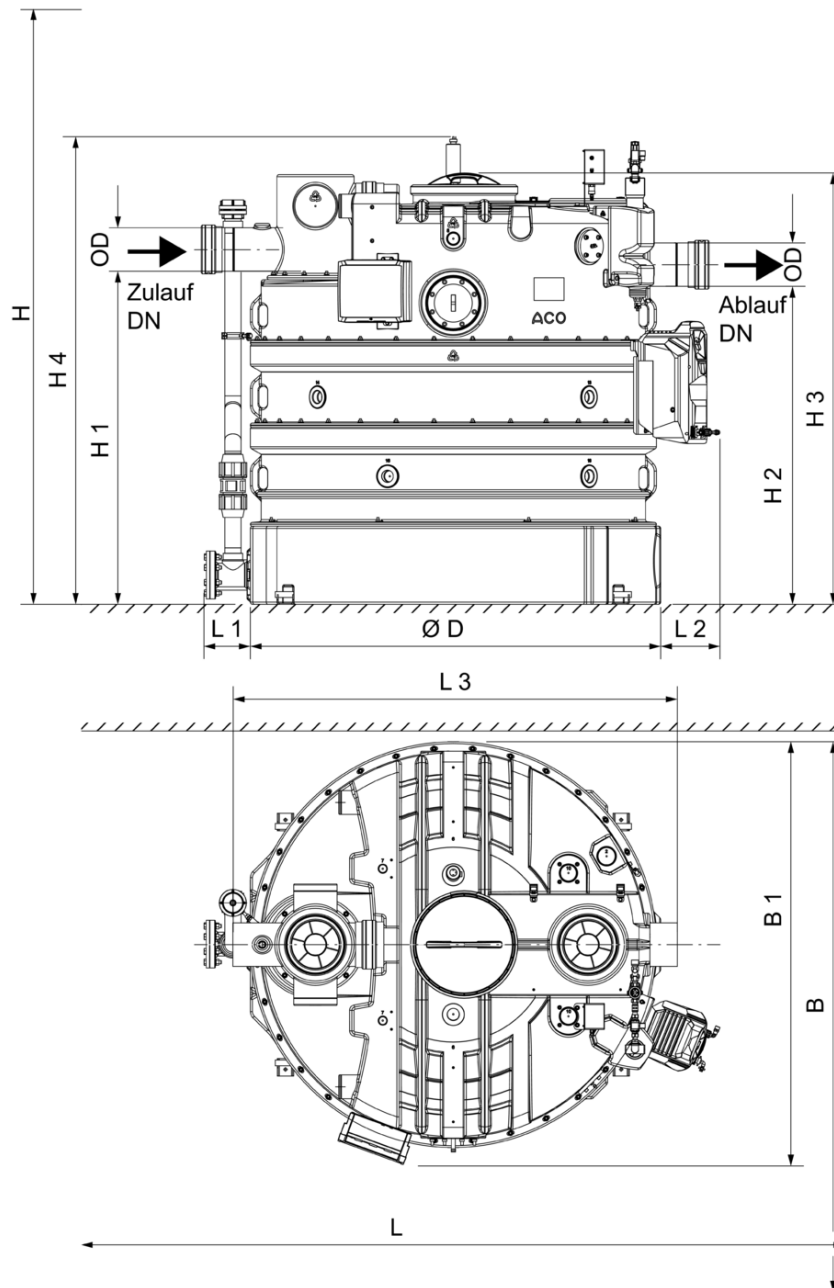













Nominal size





Dimensions

	L1	L2	L3	H1	H2	H3	H4	B1	D	D1	Z/Anzahl Segmente	B
	[mm]	[mm]	[mm]	[mm]	[mm]	[mm]	[mm]	[mm]	[mm]	[mm]		[mm]
NS 15	210	275	2050	1535	1465	1990	2150	1900	200	1890	4	2550

Accessories

	Description	Used with	Weight [kg]	PU [piece]	Item number
	<p>Inlet valve DN 200</p> <ul style="list-style-type: none"> ■ Made out of PVC ■ Push socket 200 mm with lip sealing ring on both sides ■ Total dimensions: 264 x 637 mm (L x H) 	<ul style="list-style-type: none"> ■ Wastewater lifting plant <ul style="list-style-type: none"> □ Multi-Star DDP 1/2 ■ Grease separator made of polyethylene <ul style="list-style-type: none"> □ From NS 15 	8.4	1	0170.20.83
	<p>Sampling pot DN 200</p> <ul style="list-style-type: none"> ■ For installation of horizontal pipes DN 200 to grease separator ■ Round shape with <ul style="list-style-type: none"> □ Coupling socket seal (material SBR) on inlet and spigot on outflow □ Odour-proof maintenance opening DN 450 	<ul style="list-style-type: none"> ■ Grease separator LipuJet-P <ul style="list-style-type: none"> □ NS 15 – 22,5 	10.3		3300.09.31
	<p>Sampling pot DN 200</p> <ul style="list-style-type: none"> ■ For installation in vertical pipes DN 200 going to grease separator ■ Round shape with <ul style="list-style-type: none"> □ Coupling socket seal (material SBR) on inlet and spigot on outflow □ Odour-proof maintenance opening DN 450 	<ul style="list-style-type: none"> ■ Grease separator LipuJet-P <ul style="list-style-type: none"> □ NS 15 – 22,5 	10.2		3300.10.31
	<p>Grease layer thickness measuring device</p> <ul style="list-style-type: none"> ■ For electronic measurement of layer of grease ■ Suitable for liquid and/or congealing grease ■ Measuring device with plug and used connecting cable, length: 3 m ■ With two voltage-free changeover contacts to display full warning (80%) and advance warning of fill level (50%) ■ With visual display of fill level ■ With heated probe rod to increase reliability of operation ■ Operating voltage: 230VAC/5 VA ■ Max consumption approx. 12W 	<ul style="list-style-type: none"> ■ LipuJet-P <ul style="list-style-type: none"> □ Oval NS 1 – 10 □ Round NS 2 – 22,5 ■ LipuJet-S <ul style="list-style-type: none"> □ Oval NS 1 – 10 □ Round NS 2 – 20 ■ LipuSmart-P <ul style="list-style-type: none"> □ Oval NS 1 – 10 	2.8		3300.11.50
	<p>Coarse trap DN 200</p> <ul style="list-style-type: none"> ■ For installation in vertical pipes DN 200 going to grease separator ■ Round shape with <ul style="list-style-type: none"> □ Coupling socket seal (material SBR) on inlet and spigot on outflow □ Basket made from stainless steel, material grade 316 to retain coarse substances □ Odour-proof maintenance opening DN 450 	<ul style="list-style-type: none"> ■ Grease separator LipuJet-P <ul style="list-style-type: none"> □ NS 15 – 22,5 	9.9		3667.00.06

	Description	Used with	Weight [kg]	PU [piece]	Item number
	Heating rod <ul style="list-style-type: none"> ■ To liquefy grease layer ■ Incl. control ■ Electrical connector <ul style="list-style-type: none"> □ 400 V/50 Hz/6.0 kW 	<ul style="list-style-type: none"> ■ Grease separators 	15.0		7300.01.00
	Connection box <ul style="list-style-type: none"> ■ For evacuation connection and remote control ■ Made from stainless steel, material grade 304 ■ Fixing: "On wall" ■ Dimensions (width x height x depth): 500 x 500 x 160 mm 	<ul style="list-style-type: none"> ■ Grease separators ■ Starch separators ■ LipuLift-P-D/-DA/-DAP 	11.6		7601.80.20
	In-wall frame <ul style="list-style-type: none"> ■ Dimensions (width x height x depth): 565 x 565 x 15 mm 	<ul style="list-style-type: none"> ■ Connection box <ul style="list-style-type: none"> □ 7601.80.20 ■ LipuLift-P-D/-DA/-DAP 	1.2		7601.80.21
	Stop valve <ul style="list-style-type: none"> ■ Made of cast iron ■ Penstock plate, spindle made from stainless steel, material grade 304 				
	DN 200; Length (L): 60 mm; Spindle travel (H1 – H2): 542 – 743 mm; Manual wheel diameter: 250 mm	<ul style="list-style-type: none"> ■ Grease separator for free-standing installation; <ul style="list-style-type: none"> □ NS 15-20 	36.0		7610.00.12
	Flange connection part <ul style="list-style-type: none"> ■ Stainless steel, material grade 304 ■ Seal: NBR 				
	DN 200; Length (L): 120 mm	<ul style="list-style-type: none"> ■ Stop valve DN 200; <ul style="list-style-type: none"> □ 7610.00.12 	12.9		7610.00.13
	Connection box <ul style="list-style-type: none"> ■ For evacuation connection DN 80 ■ Made from stainless steel, material grade 304 ■ "On wall" version ■ Door stop <ul style="list-style-type: none"> □ Choice of left or right □ Lockable door ■ Dimensions (width x height x depth): 370 x 330 x 250 mm 	<ul style="list-style-type: none"> ■ Grease separators <ul style="list-style-type: none"> □ LipuMax-P-D/DM/DA □ LipuJet-P-OD/RD/SD/OM/OMP/RM/RMP □ LipuJet-S-OD/RD/SD/OM/OMP/RM/RMP ■ Stach separators FapuMax-P-DA ■ Oil separators Coalisator-P ■ LipuLift-P-D/-DA/-DAP 	10.4		7601.80.22
	In-wall frame <ul style="list-style-type: none"> ■ Stainless steel, material grade 304 ■ Dimensions (width x height x depth): 421 x 381 x 25 mm 	<ul style="list-style-type: none"> ■ Connection box <ul style="list-style-type: none"> □ 7601.80.22 ■ LipuLift-P-D/-DA/-DAP 	1.0		7601.80.23
	Remote control <ul style="list-style-type: none"> ■ For internal fitting or fitting in connection boxes ■ Control line without protective conductor on-site <ul style="list-style-type: none"> □ Up to 50 m: 7 x 1.0 mm² □ 50 – 200 m 7 x 1.5 mm² 				

	Description	Used with	Weight	PU	Item number
			[kg]	[piece]	
		Grease separator; <input type="checkbox"/> LipuJet-P OA/OAP/RA/RAP <input type="checkbox"/> LipuJet-S OA/OAP/RA/RAP <input type="checkbox"/> LipuMax-P-DA <input type="checkbox"/> LipuSmart-P-OA/OAP ; Starch separator Fapujet	1.0		0150.59.89
	Storz coupling for swinging gas lines ■ Storz coupling 75B ■ For connection of the disposal vehicle pendulum gas line ■ For pipe connection Rp 2 ½" (female thread)	■ For installation in connection box art. no. 7601.80.22	1.8		0155.32.09
	Grease layer thickness measuring device Multi Control ■ To determine the disposal intervals of grease separators ■ Suitable for liquid and/or harden fats ■ Delineation with colour-touchpanel ■ With integrated SD-card (4GB) for recording of the measuring process ■ With headed sounding stick (temperature is adjustable) to increase the operation safety ■ Three free of potential contacts for output of pre-alarm (adjustable), full-alarm (adjustable) and error ■ Measuring stick with adjusting scale ■ Delineation with plug-in cable connection, 3 m ■ Service voltage: 100 240VAC 50/60 Hz, 2 A ■ Power: ca. 43 W	■ LipuJet-P <input type="checkbox"/> Oval NS 1 – NS 30 <input type="checkbox"/> Round NS 2 – NS 20 ■ LipuJet-S <input type="checkbox"/> Oval NS 1 – NS 10 <input type="checkbox"/> Round NS 2 – NS 20 ■ LipuSmart-P <input type="checkbox"/> Oval NS 1 – 10	2.7		3300.12.50
	Connection box ■ For disposal connection, pendulum gas line (if necessary) and remote control ■ From stainless steel, material grade 304 ■ "Surface mounted" version ■ Glass beaded front ■ Lockable door, left limit stop ■ Dimensions W x H x D: 300 x 725 x 160 mm	■ Grease separator ■ Starch separators ■ LipuLift-P-D/-DA/-DAP	10.0		7601.80.24
	In-wall frame ■ From stainless steel, material grade 304 ■ "In-wall" version ■ Glass beaded front ■ Dimension W x H x D: <input type="checkbox"/> 405 x 830 x 30 mm	■ Connection box <input type="checkbox"/> 7601.80.24 ■ LipuLift-P-D/-DA/-DAP	2.1		7601.80.25

Description	Used with	Weight	PU	Item number
		[kg]	[piece]	
 <p>ACO Ozone Generator</p> <ul style="list-style-type: none"> ■ ACO Ozone minimizes odors that can arise from grease separators, lifting plants and pumping stations ■ Material: acid-resistant stainless steel <p>Consists:</p> <ul style="list-style-type: none"> ■ ACO Ozone - ozone generator <ul style="list-style-type: none"> □ Size (L x W x H): 270 x 100 x 85 mm □ Nominal voltage 230 V / 50 Hz □ Degree of protection IP20 ■ ACO Ozone pump - feed pump <ul style="list-style-type: none"> □ Size (L x W x H): 160 x 90 x 90 mm □ Integrated filter □ Nominal voltage 230 V / 50 Hz □ Degree of protection IP54 ■ ACO Ozone bracket - wall bracket <ul style="list-style-type: none"> □ Size (L x W x H): 295 x 110 x 90 mm ■ Hoses 	<ul style="list-style-type: none"> ■ Grease separators, indoors ■ Grease separators, outdoors ■ Lifting stations ■ Pumping stations 			7980.90.00
 <p>Message system with GSM module</p> <ul style="list-style-type: none"> ■ Parameter via app (Android & iOS) ■ Mains-independent alarm via 12V lead-gel battery ■ Optical and acoustic alarm message ■ Freely configurable inputs <ul style="list-style-type: none"> □ 6 digital inputs with LED status display □ 1 analogue ■ 1 alarm output 12 V ■ Alarm forwarding via SMS to mobile phones ■ For mounting outside the hazardous area ■ Housing: 192 x 150(with cable gland) x 100 mm (WxHxD) ■ Protective doctor: IP54 ■ Operating voltage: 230 V/AC 50/60 Hz 	<ul style="list-style-type: none"> ■ All grease separators ■ Grease layer thickness measuring device ■ Pre-tank plants ■ Technical processing systems ■ Quatrix-K backflow preventer type 3F ■ Sinkamat-K (underfloor) duo ■ Multi lifting units ■ Pumping stations ■ Installation sets 	2.0	1	0150.80.14
 <p>Connection cable antenna GSM</p> <ul style="list-style-type: none"> ■ Length incl. connections: approx. 15 m ■ Cable type: RG58 ■ Connections: 1 x SMA plug (SMA/M) and 1 x SMA socket (SMA/F) ■ Only one extension cable may be used per GSM module ■ Usable in temperature range: -20°C to 85°C 	<ul style="list-style-type: none"> ■ GSM - Modul 			0150.83.86
 <p>Operating Logbook</p> <ul style="list-style-type: none"> ■ Contents: Check-list and standard forms to document in-house monitoring, maintenance and disposal relating to the plant as required by DIN 4040-100 ■ Format: A4 with double filing rings ■ Size: 60 pages ■ Laid out to cover 5 years 	<ul style="list-style-type: none"> ■ Grease separator <ul style="list-style-type: none"> □ For underground installation □ For free-standing installation 	0.3		0150.45.23

You can find further accessories under → <https://www.buildingdrainage.aco/search/?q=3515.53.10>